

# FORM-WORK BAR CHAIR PC 45/50



**BAR CLIP MECHANISM**



**HEAVY DUTY DESIGN**

*“What I love about your chairs is the low visibility feet - it makes my finished product look heaps better.”*

– Dan, Precast Yard

## The features of our **FORM-WORK BAR CHAIR 45/50**

One of the forerunners to the now popular Castle pre-cast chairs the F45/50 form-work chair has been designed to support single layered mesh or bar up to 10mm Diameter. Featuring a handy clip on feature allows to mount horizontally without falling down. Recommended for use in form and cage applications.

Heavy duty design makes for a superbly stable steelwork chair.

These chairs are batch tested and meet the AS/NZS 2425:2015 Standards for bar chairs in reinforced concrete.

**Tip:**

The clip mechanism allows the chair to attach firm in a horizontal position when lowering the mesh into form. Great!

**PAGE 2**

FOR MORE INFO



**0800 55 33 00**

## APPLICATIONS

- Formwork
- Cage spacing.

## FEATURES AND BENIFITS

- Rugged and versatile design
- Fits up to 10mm bar size
- Clip mechanism allows the chair to hold in a horizontal position when lowering the mesh into form.

## TECHNICAL CHARACTERISTICS

Code	F45/50
Cover	45 & 50mm
Diameter	55mm
Colour	Grey
Bag Quantity	200 units
Bag Weight	4.7kg
Pallet Quantity	5000 units
Pallet Weight	140kg
Pallet Cubic Area (m3)	1.5m3
Test Standards	AS/NZS 2425:2015

## EVERYDAY APPLICATION

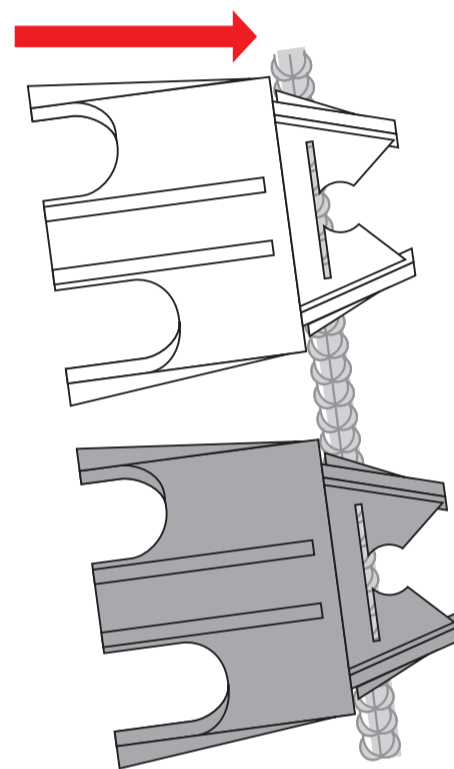

- Step 1: Clip Spacer to Reo Bar at desired height
- Step 2: Let spacer hold in horizontal position.

## TECHNICAL DIMENSIONS

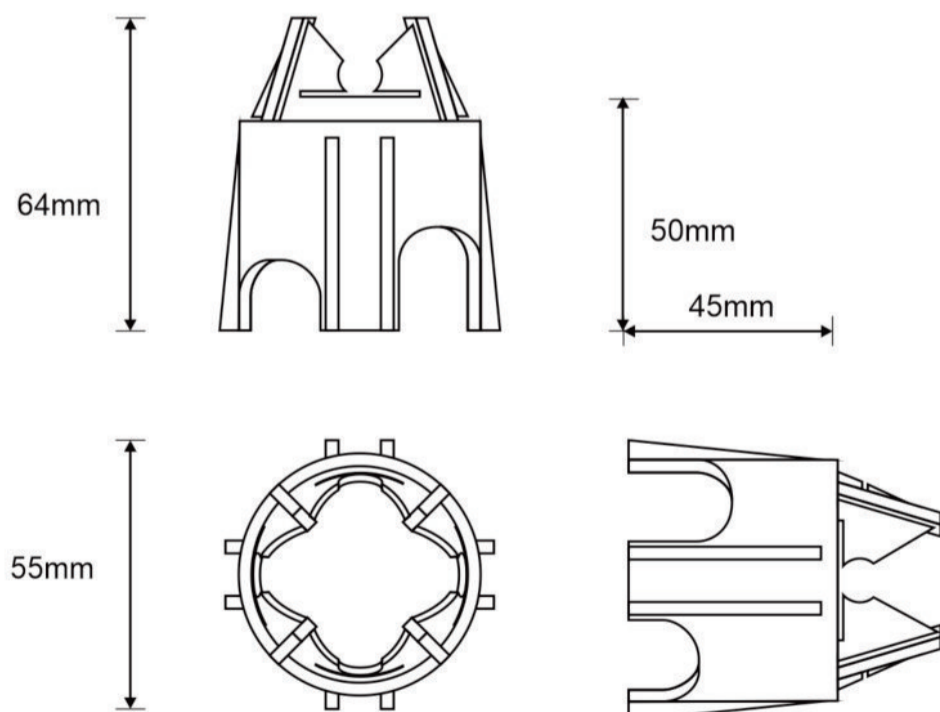

## TEST DATA

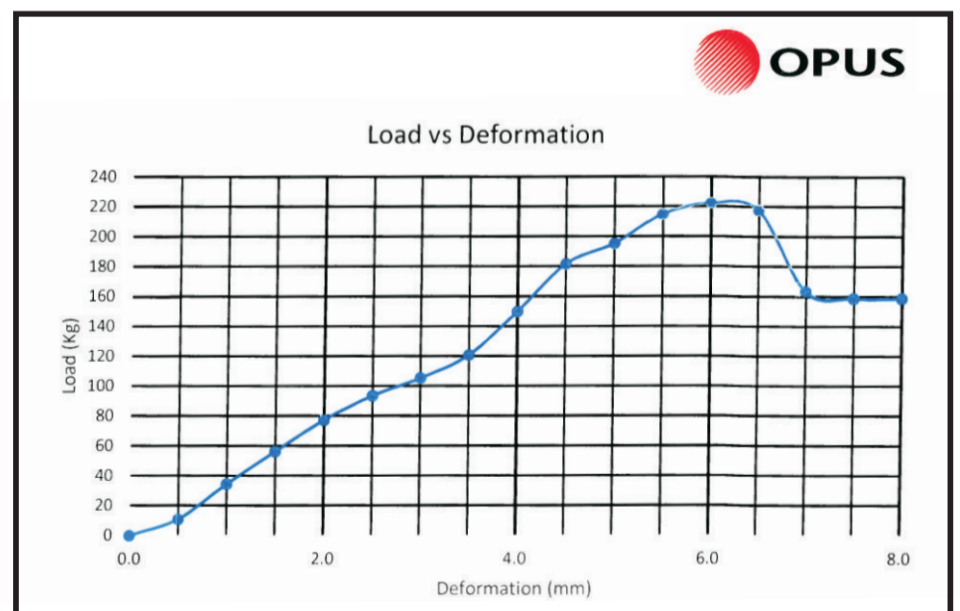

Date tested : 14/10/16  
Date reported : 17/10/16

Approved : *A.Ching*  
Designation : Laboratory Manager  
Date : 17/10/16